

CCD COLOR CAMERA

# IK-64WDA

Please read this manual thoroughly before use, and keep it handy for future reference.

Record in space provided below the Model No. and the Serial No. as found on the label on the bottom of this unit.

Model No. IK-64WDA Serial No. \_\_\_\_\_

Retain this information for future reference.

## TABLE OF CONTENTS

### Important Safeguards

1. Features & Description	3
2. Cautions	2
3. Components	3
4. Part Name & Functions	4
5. Connections and Operations	5
6. Line-Lock Phase	8
7. Menu-Driven set-up	8
8. Note on Use and Installation	14
9. In Case of Problems	15
10. Specifications	16
11. Exterior View	17

# IMPORTANT SAFEGUARDS

- 1. Read Instructions**

All the safety and operating instructions should be read before the product is operated.
- 2. Retain Instructions**

The safety instructions and instruction manual should be retained for future reference.
- 3. Heed Warnings**

All warnings on the product and in the instruction manual should be adhered to.
- 4. Follow Instructions**

All operating and use instructions should be followed.
- 5. Cleaning**

Disconnect this video product from the power supply before cleaning.
- 6. Attachments**

Do not use attachments not recommended by the video product manufacturer as they may cause hazards.
- 7. Water and Moisture**

Do not use this video product near water- for example, near a bath tub, wash bowl, kitchen sink, or laundry tub, in a wet basement, or near a swimming pool and the like.
- 8. Accessories**

Do not place this video product on an unstable cart, stand, tripod, bracket or table. The video product may fall, causing serious injury to a child or adult, and serious damage to the product. Use only with stand, tripod, bracket, or table recommended by the manufacturer, or sold with the video product. Any mounting of the product should follow the manufacturer's instructions, and should use a mounting accessory recommended by the manufacturer.
- 9. Ventilation**

This video product should never be placed near or over a radiator or heat register. This video product should not be placed in a built-in installation such as a bookcase or rack unless proper ventilation is provided or the manufacturer's instructions have been adhered to.
- 10. Power Sources**

This video product should be operated only from the type of power source indicated on the marking label. If you are not sure of the type of power supply to your location, consult your product dealer.
- 11. Power-Cord Protection**

Power-Supply cords should be routed so that they are not likely to be walked on or pinched by items placed upon or against them, paying particular attention to cords at plugs, screws and the point where they exit from the product.
- 12. Lightning**

For added protection for this video product during a lightning storm, or when it is left unattended and unused for long periods of time, unplug it from the wall outlet and disconnect the power supply and cable system. This will prevent damage to the video product due to lightning and power-line surges.
- 13. Overloading**

Do not overload power supply and extension cords as this can result in a risk of fire or electric shock.
- 14. Object and Liquid Entry**

Never push objects of any kind into this video product through openings as they may touch dangerous voltage points or short-out parts that could result in a fire or electrical shock. Never spill liquid of kind on the video product.
- 15. Servicing**

Do not attempt to service this video product yourself as opening or removing covers may expose you to dangerous voltage or other hazards. Refer all servicing to qualified service personnel.
- 16. Damage Requiring service**



Disconnect this video product from the power supply and refer servicing to qualified service personnel under the following conditions.

  - a. when the power-supply cord or plug is damaged.
  - b. if liquid has been spilled, or objects have fallen into the video product.
  - c. if the video product has been exposed to rain or water.
  - d. if the video product does not operate normally by following the operating instructions in the instruction manual. Adjust only those controls that are covered by the instruction manual as an improper adjustment of other controls may result in damage and will often require extensive work by a qualified technician to restore the video product to its normal operation.
  - e. If the video product has been dropped or the cabinet has been damaged.
  - f. When the video product exhibits a distinct change in performance-this indicates a need for service.

- 17. Replacement Parts**

When replacement parts are required, be sure the service technician has used replacement parts specified by the manufacturer with the same characteristics as the original part. Unauthorized substitutions may result in fire, electric shock or other hazards.
- 18. Safety Check**

Upon completion of any service or repairs to this video product, ask the service technician to perform safety checks to determine that the video product is in proper operating condition.

	<b>CAUTION</b> RISK OF ELECTRIC SHOCK DO NOT OPEN	
REDUCE CAUTION TO REDUCE THE RISK OF ELECTRIC SHOCK. DO NOT REMOVE COVER (OR BACK). NO USER SERVICEABLE PARTS INSIDE. REFER SERVICING TO QUALIFIED SERVICE PERSONNEL.		

- The CAUTION label, shown on the left, is attached on the bottom of camera.



The lightning flash with arrowhead symbol, within an equilateral triangle, is intended to alert the user to the presence of uninsulated "dangerous voltage" within the product's enclosure that may be of sufficient magnitude to constitute a risk of electric shock to persons.



The exclamation point within an equilateral triangle is intended to alert the user to the presence of important operating and maintenance (servicing) instructions in the literature accompanying the appliance.

**WARNING :**

TO REDUCE THE RISK OF FIRE OR ELECTRIC SHOCK, DO NOT EXPOSE THIS APPLIANCE TO RAIN OR MOISTURE.

• **CAUTION**

CONNECT 24V AC UL LISTED CLASS 2 POWER SUPPLY.

**FIELD INSTALLATION MARKING :**

WORDED : "THIS INSTALLATION SHOULD BE MADE BY A QUALIFIED SERVICE PERSON AND SHOULD CONFORM TO ALL LOCAL CODES."

**INFORMATION**

This equipment has been tested and found to comply with the limits for a Class A digital device, pursuant to Part 15 of the FCC Rules. These limits are designed to provide reasonable protection against harmful interference when the equipment is operated in a commercial environment. This equipment generates, uses, and can radiate radio frequency energy and, if not installed and used in accordance with the instruction manual, may cause harmful interference to radio communications. Operation of this equipment in a residential area is likely to cause harmful interference in which case the user will be required to correct the interference at his own expense.

**USER-INSTALLER CAUTION :** Your authority to operate this FCC verified equipment could be voided if you make changes or modifications not expressly approved by the party,

# 1. FEATURES & DESCRIPTION:

1. IK-64WDA has following function.

- (1) 133 Times Dynamic Range  
Toshiba developed algorithms that enable industry leading dynamic range
- (2) Digital Noise Reduction ("DNR")  
Exclusive 3 Dimensional Digital Noise Reduction boosts s/n ratio to an incredible 53dB
- (3) 0.003Lux @ 1.2 Minimum Illumination  
User-definable Sensitivity levels ensure best image quality reproduction dependent on available light conditions
- (4) User-Definable DAY/NIGHT Threshold  
Customize the color to black & white conversion level according to your application needs
- (5) MENU-DRIVEN Programming
- (6) Up to 1/100,000 Speed Shutter
- (7) 480+ Lines of Resolution
- (8) This camera can be easily installed into any AC 24V ~ / DC 12V system

## 2. Cautions:

- (1) In order to protect the camera, avoid placing or using it under direct sunlight, rain or dust.
- (2) Avoid touching the CCD sensor with your fingers. If necessary, use a soft cloth moistened with alcohol to wipe off any dust.
- (3) When the camera is not in use, keep the lens or lens cap attached to protect the CCD sensor.
- (4) Avoid aiming the camera at the sun.
- (5) Avoid shooting the camera at intense light. Intense light such as a spotlight may cause a bloom or smear. A vertical stripe may appear on the screen. However, this is not a malfunction.
- (6) Install the camera away from video noise. If cables are wired near electric lighting wires or a TV set, noise may appear in images. In this event, relocate cables or reinstall equipment.

## 3. Components:

---

- |  |                    |
|--|--------------------|
| (1) Camera   | 1                  |
| (2) Accessories  |                    |
| (a) Lens Connector   | 1 (E4-191J-100(M)) |
| (b) Instruction Manual   | 1                  |
| (c) Lens Cap   | 1                  |
| (d) Lens, coaxial cable and power cord are not supplied with the camera. |                    |

# 4. PART NAMES & FUNCTIONS :

Auto-IRIS Terminal  
When using an auto-iris it needs to be connected to this terminal.

Left side View

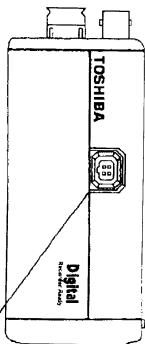

Focus ring :  
Rotate the ring to appropriate setting.

Front View

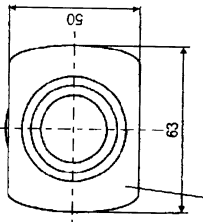

Videoc output terminal :  
connect to a TV monitor, etc.

Top View

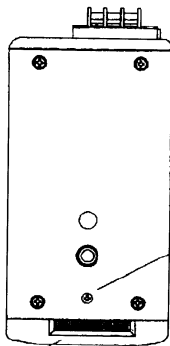

Focus Lock Screw

Rear View

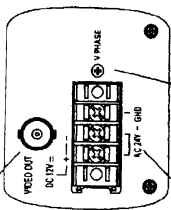

AC 24V ~ /DC 12 ...  
power terminal

V PHASE :  
Line-Lock Phase  
adjustment trimmer

Right Side View

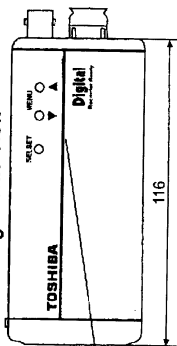

Lens :  
Mount a CS-mount lens.

SHUTTER / WDR / IRIS  
GAIN / SYNC / SHARPNESS  
WHITEBAL / I.D.

## 5. CONNECTIONS AND OPERATIONS

### Notes on connecting

- Power plugs of connected equipment must be disconnected before installations.
  - A 75-ohm coaxial cable (3C-2V or 5C-2V) is required for standard connection.
  - For details of wiring and operation of equipment to be connected, refer to their operation manuals.
  - Lenses, coaxial cables for video signals and the power cord are not supplied with the camera.
- Refer to the operations manuals of connected equipment for detailed wiring and overall operation instructions.

### 5-1 Basic connection single system configuration

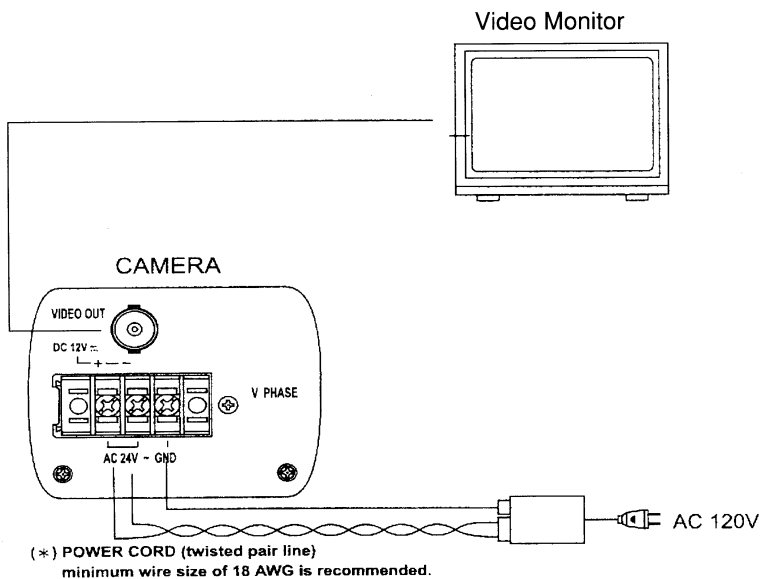

24V AC UL Listed Class 2 power supply / 12V DC power supply

CAUTION : Never input 24V AC and 12V DC at the same time.

### Do not overload power supply

Since this camera uses 24V AC UL Listed Class 2 power supply or 12V DC power supply, it should be connected to a power supply that allows for at least 7w consumption.

## 5-2 Line-Lock Control

- Matching the vertical synchronization with the power frequency is called the Line-Lock.
- This function is activated when the SYNC menu is selected to LL.
- When two or more cameras are switched by the video switcher for viewing by a monitor TV, the vertical sync. phase can be locked with the power frequency, and a stable vertical sync. is obtained without being disturbed at the time of switching.

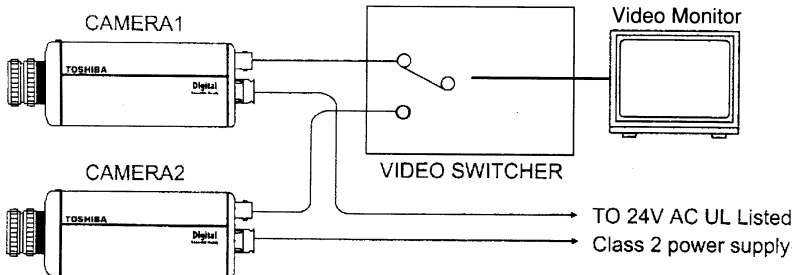

### Note :

- The camera is synchronized to the power frequency of  $60 \pm 1$  Hz covering a normal fluctuation of the power frequency. However, the camera may not cover a large fluctuation caused from the power generated by an engine generator, etc.
- It takes about 10 seconds or more until a stable synchronization is obtained after the power is turned on. This is normal, because several seconds are required to stabilize the camera against power noise.
- Refer to "6. LINE-LOCK PHASE" for adjustment.

## 5-3 Operation

- (1) Before mounting a lens, check whether it is a "C" mount or "CS" mount type lens. If a "C" mount lens is used, an adapter ring is required and the back focus will need to be adjusted.
- (2) Mount the lens on the camera by turning the lens clockwise. Adjust the diaphragm and focus for optimum image.
- (3) Connect the VIDEO output to the video monitor. The picture will appear on the monitor screen as the power is supplied to the camera.
- (4) Adjust the focus and aperture of the lens for best image quality.

## (5) Back focus adjustment:

Back focus is adjusted at the factory to accommodate most standard lenses. If a slight adjustment is needed, mount the lens to the camera first. Then loosen the Focus Lock Screw. Rotate the Focus ring until a clear image is achieved. Retighten the Focus Lock Screw.

### NOTE

When the lens weight is more than 2.2 lbs., support the camera on the lens side rather than relying on the tripod mount of the camera.

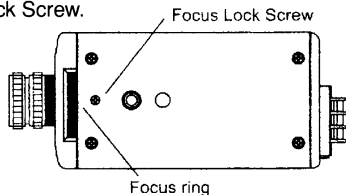

This camera supports DC (direct drive) type of auto-iris lens:

Connect the auto-iris connector plug to the IRIS terminal on the side of the camera. Refer to the chart below for correct wiring and set up.

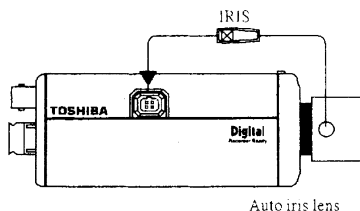

	Direct Drive IRIS Lens
<b>IRIS terminal pin</b>	1. Damp - (y)
	2. Damp + (y)
	3. Driver + (wh)
	4. Driver - (g)

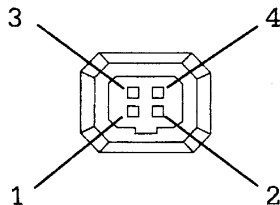



## 6. LINE LOCK PHASE

When a video switcher switches two or more cameras, the picture may fluctuate on the video monitor due to the different AC line phase of each camera. In this case, adjust the V PHASE controller (on rear panel) to get a stable image.

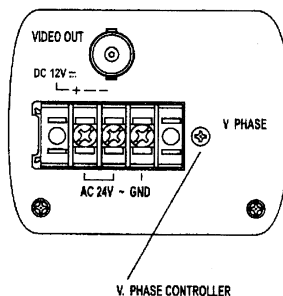

## 7. MENU DRIVEN SET-UP

The following is the on-screen menu structure for all settings and adjustments of the camera.

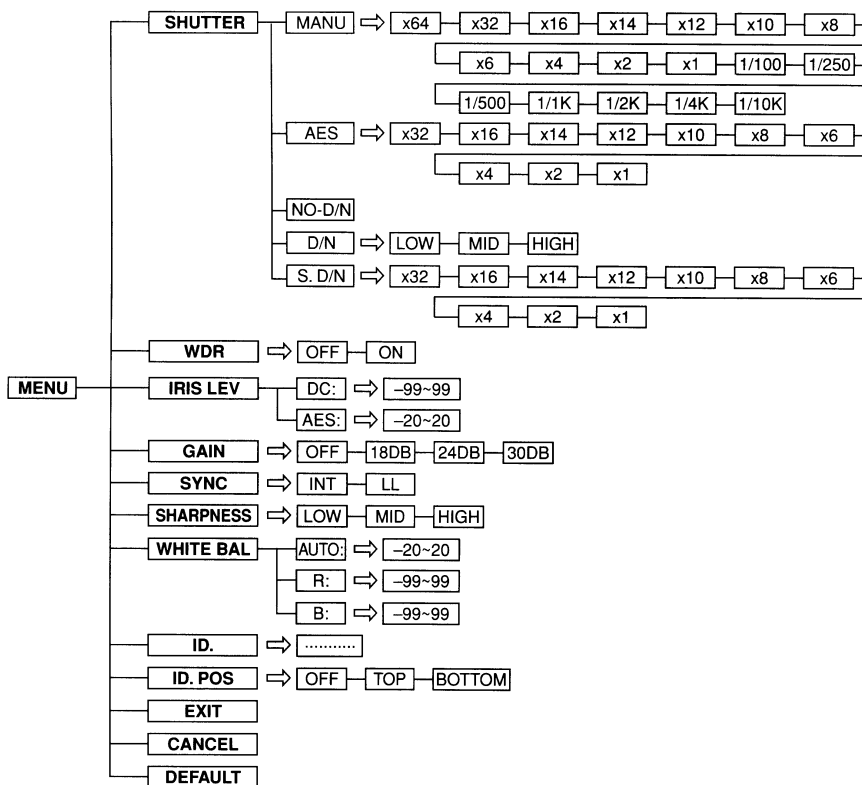

## 7-1. Setting switches and the functions

On the side panel of the cameras there are three push button switches as shown below:

Switch name	Main function
Select	Setting mode call on/off, setting entry
▼	Setting item selection (down)
▲	Setting item selection

### 7-2 On Screen Menu

The camera is adjusted using the On Screen Menu. Press and hold the select switch on the side of the camera body 2 seconds until the menu appears on the monitor. The shaded area represents the option to be set.

```

SHUTTER      D/N:MID
WDR           ON
IRIS LEV    DC:00
GAIN         24DB
SYNC        LL
SHARPNESS   MID
WHITE BAL   AUTO:00
NEXT
EXIT CANCEL DEFAULT
ID. POS     OFF
ID.
.....
BACK
EXIT CANCEL DEFAULT
    
```

#### 7-2-1. Shutter (Exposure time)

Move the cursor to the position in Fig.

Use the SELECT switches to select MANU,

AES, NO-D/N, D/N, S.D/N.

A. MANU (Manual shutter)

Use the ▲▼ button to choose the shutter speed from x64 through 1/10k.

B. AES

Exposure time is controlled automatically within a range of 1/60 sec, to 1/100,000 sec. to obtain an adequate signal.

Use the ▲▼ button to choose the slow shutter speed from x32 through x1 (1/60).

C. NO-D/N (NO DAY/NIGHT FUNCTION)

Exposure time is fixed 1/60 sec.

The control of the luminosity is done with the DC Lens.

D. D/N (DAY/NIGHT function)

In low light conditions the IK-64WDA automatically cuts the chroma signal level and boosts the gain up of the luminance by 6dB.

a. LOW: The chroma cut level is set less than 20 to 30 IRE.

b. MID: The chroma cut level is set less than 30 to 40 IRE.

c. HIGH: The chroma cut level is set less than 40 to 50 IRE.

"HIGH" is for a brighter setting than "LOW"

```

SHUTTER      D/N:MID
WDR           ON
IRIS LEV    DC:00
GAIN         24DB
SYNC        LL
SHARPNESS   MID
WHITE BAL   AUTO:00
NEXT
EXIT CANCEL DEFAULT
ID. POS     OFF
ID.
.....
BACK
EXIT CANCEL DEFAULT
    
```

### E. S.D/N (SUPER DAY/NIGHT FUNCTION)

Under the low light condition, the IK-64WDA automatically activates the slow shutter function.

#### Practical Application

SHUTTER MODE	LENS TYPE	SHUTTER
MANU	Fixed iris	X64 - 1/10K
AES	Fixed iris	X32 - 1/10K
NO-D/N	Auto iris	1/60
D/N	Auto iris + (6 dB gain up)	1/60
S.D/N	Auto iris	X32 - 1/60

A DC lens opens when MANU or AES mode is chosen.

### 7-2-2 WDR (WIDE DYNAMIC RANGE FUNCTION)

Move the cursor to the position shown in fig.

Use the st ▲▼ SELECT switches to select OFF or ON in the WDR setting

When WDR is set to ON, WDR activates automatically.

When WDR function is activated, the video of each field is mixed. When this happens, vertical resolution and the number of the frames decrease slightly.

When the SHUTTER mode is set to MANU, the WDR function is disabled.

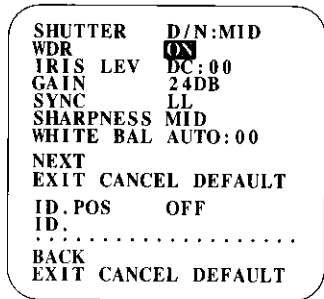

### 7-2-3 IRIS LEV (IRIS LEVEL)

Move the cursor to the position shown in fig.

Use the ▲▼ SELECT switches to adjust the IRIS level to reach the desired luminosity.

AES is displayed when the SHUTTER mode is set to AES, except when used with DC.

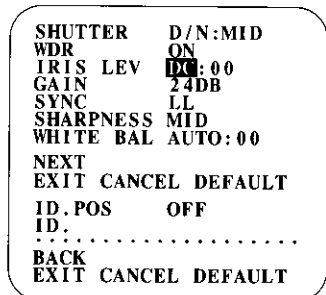

## 7-2-4 GAIN (AGC)

Move the cursor to the position shown in fig.  
Use the ▲▼ SELECT switches to select OFF,  
18dB, 24dB, 30dB.

A. OFF

B. 18dB (Low-Sensitivity position, max gain = 18dB)

C. 24dB (Standard position, max gain = 24dB)

D. 30dB (High-Sensitivity position, max  
gain=30dB)

When using the camera in low light, use the 30dB  
GAIN setting.

```
SHUTTER  D/N:MID
WDR      ON
IRIS LEV DC:00
GAIN     24DB
SYNC     LL
SHARPNESS MID
WHITE BAL AUTO:00
NEXT
EXIT CANCEL DEFAULT
ID. POS  OFF
ID.:
.....
BACK
EXIT CANCEL DEFAULT
```

## 7-2-5 SYNC

Move the cursor to the position shown in fig.  
Use the ▲▼ SELECT switches to select INT or  
LL in the SYNC setting

A. INT: The camera is in the internal SYNC  
mode

B. LL: The camera is in the Line-Lock Mode. Line-  
Lock phase is set 0 - 300 degrees by  
adjusting the V phase control at the rear of  
the camera. Refer to 5. Connections and  
Operations

```
SHUTTER  D/N:MID
WDR      ON
IRIS LEV DC:00
GAIN     24DB
SYNC     LL
SHARPNESS MID
WHITE BAL AUTO:00
NEXT
EXIT CANCEL DEFAULT
ID. POS  OFF
ID.:
.....
BACK
EXIT CANCEL DEFAULT
```

## 7-2-6 SHARPNESS

Move the cursor to the position shown in fig.  
Use the ▲▼ SELECT switches to select LOW,  
MID, High in the SHARPNESS setting.

```
SHUTTER  D/N:MID
WDR      ON
IRIS LEV DC:00
GAIN     24DB
SYNC     LL
SHARPNESS MID
WHITE BAL AUTO:00
NEXT
EXIT CANCEL DEFAULT
ID. POS  OFF
ID.:
.....
BACK
EXIT CANCEL DEFAULT
```

### 7-2-7 WHITE BAL (WHITE BALANCE)

Move the cursor to the position shown in fig.  
Use the ▲▼ SELECT switches to select AUTO,  
MANUAL in the WHITE BAL settings.

- A. AUTO: The white balance is automatically adjusted corresponding to the color temperature variations on the object. The camera is applicable to a color temperature range of 2500 - 10K. Press the SELECT switch to enter AUTO set mode. Use the ▲▼ SELECT switches to adjust the shift value of the convergence point. When data becomes big in the positive side, a convergence point is altered in the blue side. When data becomes big in the negative side, a convergence point is altered in the red side.
- B. MANUAL: Press the SELECT switch to enter the MANUAL SETTINGS. Use the ▲▼ SELECT switches to adjust R Gain (Red) and B Gain (Blue) until the desired white balance is reached. Press SELECT to exit the manual settings.

```

SHUTTER      D/N: MID
WDR          ON
IRIS LEV    DC: 00
GAIN        24DB
SYNC        LL
SHARPNESS   MID
WHITE BAL   AUTO: 00
NEXT
EXIT CANCEL DEFAULT
ID. POS     OFF
ID.: .....
BACK
EXIT CANCEL DEFAULT

```

### 7-2-8 . ID.(CAMERA ID.)

Move the cursor to the position shown in fig.  
Use the SELECT switches to name each camera  
up to 20 characters.

#### Font list

0,1,2,3,4,5,6,7,8,9

A,B,C,D,E,FG,H,I,J,K,L,M

N,O,P,Q,R,S,T,U,V,W,X,Y,Z

.,: ? + - x / & < > ( ) \* (SPACE)

```

SHUTTER      D/N: MID
WDR          ON
IRIS LEV    DC: 00
GAIN        24DB
SYNC        LL
SHARPNESS   MID
WHITE BAL   AUTO: 00
NEXT
EXIT CANCEL DEFAULT
ID. POS     OFF
ID.: .....
BACK
EXIT CANCEL DEFAULT

```

### 7-2-9 . ID. POS (CAMERA ID. POSITION)

Move the cursor to the position shown in fig.  
Use the SELECT switches to select OFF, TOP,  
BOTTEM. Show the Camera ID in monitor screen.

- A. OFF The camera ID is not displayed
- B. TOP The camera ID is displayed at the top-left of the monitor
- C. BOTTOM The camera ID is displayed at the bottom-left of the monitor.

```

SHUTTER      D/N: MID
WDR          ON
IRIS LEV    DC: 00
GAIN        24DB
SYNC        LL
SHARPNESS   MID
WHITE BAL   AUTO: 00
NEXT
EXIT CANCEL DEFAULT
ID. POS     OFF
ID.: .....
BACK
EXIT CANCEL DEFAULT

```

### 7-2-10 NEXT, BACK

**Move the cursor to the position in fig.**

Press the SELECT switch, to select the last page or next page.

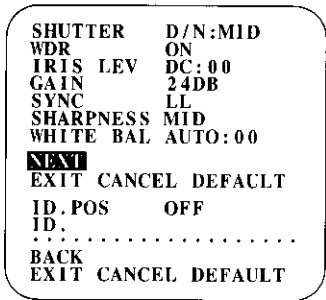

### 7-2-11 CANCEL

**Move the cursor to the position in fig.**

Press the SELECT switch to exit the menu without saving any changes.

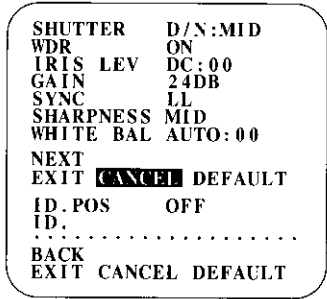

### 7-2-12 EXIT

**Move the cursor to the position in fig.**

Press the SELECT switch when SAVE ALL SETTINGS is displayed to save all changes and exit the menu.

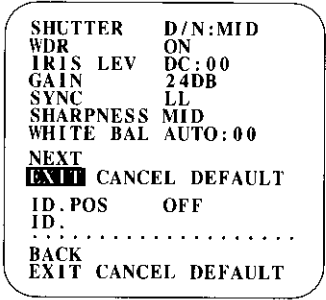

## 7-2-13 DEFAULT

Move the cursor to the position in fig.

Press the SELECT switch to select DEFAULT, which returns the camera to its factory settings.

Default settings

```
SHUTTER    D/N:MID
WDR        ON
IRIS LEV   DC:00
GAIN       24DB
SYNC       LL
SHARPNESS  MID
WHITE BAL  AUTO:00
NEXT
EXIT CANCEL DEFAULT
ID.POS     OFF
ID.
.....
BACK
EXIT CANCEL DEFAULT
```

```
SHUTTER    D/N:MID
WDR        ON
IRIS LEV   DC:00
GAIN       24DB
SYNC       LL
SHARPNESS  MID
WHITE BAL  AUTO:00
NEXT
EXIT CANCEL DEFAULT
ID.POS     OFF
ID.
.....
BACK
EXIT CANCEL DEFAULT
```

## 8. NOTES ON USE AND INSTALLATION

---

### • Do not aim the camera at the sun

Do not aim the camera at the sun or point it at sun even if you are not shooting.

### • Do not shoot intense light

Intense light such as a spotlight may cause a bloom or smear. A vertical stripe may appear on the screen. However, this is not a malfunction.

### • Treat the camera with care

Do not drop the camera or subject it to strong shock of vibration. Otherwise, the camera may malfunction.

### • Never touch internal parts

Do not touch the internal parts of the camera other than the parts specified. Otherwise, the camera may malfunction.

• **Do not splash water on the camera**

Install the camera where the camera can be kept dry. If the camera gets wet, turn off the power and contact your dealer.

• **Install the camera**

**Where no video noise appears**

If cables are wired near electric lighting wires or a TV set, noise may appear in images. In this event, relocate cables or reinstall equipment.

• **Check the ambient temperature and humidity**

Avoid using the camera where the temperature is hotter or colder than specified. Otherwise, the quality of images may deteriorate or internal parts may be affected. Special care is required to use the camera at high temperature and humidity.

• **Should you notice any trouble**

If any trouble occurs while you are using the camera, turn off the power and contact your dealer. If you continue to use the camera when there is something wrong with it, the trouble may much worse and an unpredictable accident may occur.

## **9. IN CASE OF PROBLEMS**

---

<b>Condition</b>	<b>Check Points</b>
No image	<ul style="list-style-type: none"><li>• Are the camera and connected equipment turned on?</li><li>• Is the iris of the lens adjusted properly?</li><li>• Are cables connected correctly?</li></ul>
Unnatural color	<ul style="list-style-type: none"><li>• Is the monitor TV adjusted correctly?</li><li>• Is the lighting too weak?</li></ul>

Press default to return the camera to factory settings (7.2.13)



# 10. SPECIFICATIONS

Power	AC 24V ~ ± 10% 60Hz / DC 12V --- ± 10%
Power consumption	5.5W(max) with AI lens
Image sensor	1/3 inch CCD image area sensor
Image pickup area	4.96mm (0.195inch) horizontal x 6.0mm (0.236inch) vertical (1/3inch type)
Effective picture element	768 horizontal x 494 vertical
Scanning system	2 : 1 interlace NTSC Standard TV system
Scanning frequency	15.75kHz horizontal 60Hz vertical
Synchronization	Line-Lock, Internal manually switchable
Resolution	Horizontal 480 TV lines or more Vertical 350 TV lines or more (WDR OFF) Horizontal 480 TV lines or more Vertical 260 TV lines or more (WDR On) (slow shutter)
Minimum illuminance of subject	0.1 Lux (F1.2, AGC More 30dB than 10% of image output $\gamma=0.45$ ) 0.003 Lux (F1.2, x32, AGC More 30dB than 10% of image output $\gamma=0.45$ )
S/N	53dB or more (AGC off, WDR off, weight ON) 50dB or more (AGC off, WDR on, weight ON)
Video output	VBS 1.0V p-p / 75 ohms, composite
Output impedance	75Ω unbalanced
White balance	Automatic (2500K to 10,000K), MANUAL
Iris control	Iris Driver Circuit Built in
Gain control	Average AGC, 30dB, 24dB, 18dB, OFF
Backlight compensation	Wide dynamic range function
Lens mount	CS mount
Ambient temperature	-10°C to + 50°C (14°F to 122°F)
Ambient humidity	30% to 90%
Weight	500g
External dimensions	2.74(W) x 1.97(H) x 4.56(D) inches (63x50x116mm)
Automatic electronic shutter	ON (1/60s to 1/100000) / OFF (1/60s)
Sens-up limit (slow shutter)	OFF/x2, x4, x6, x8, x10, x12, x14, x16, x32, x64

# 11. EXTERIOR VIEW

Left Side View

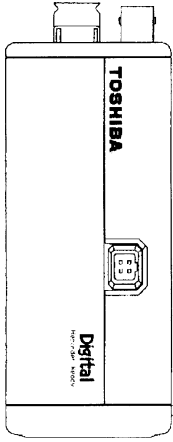

Front View

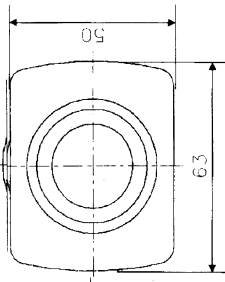

Top View

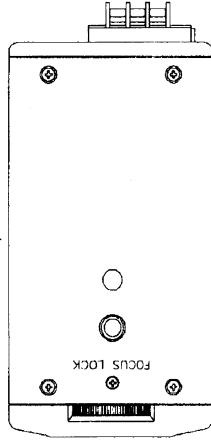

Rear View

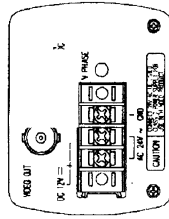

Right Side View

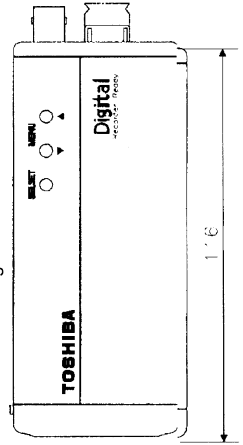

Dimensions = mm

# Camera Installation Guide

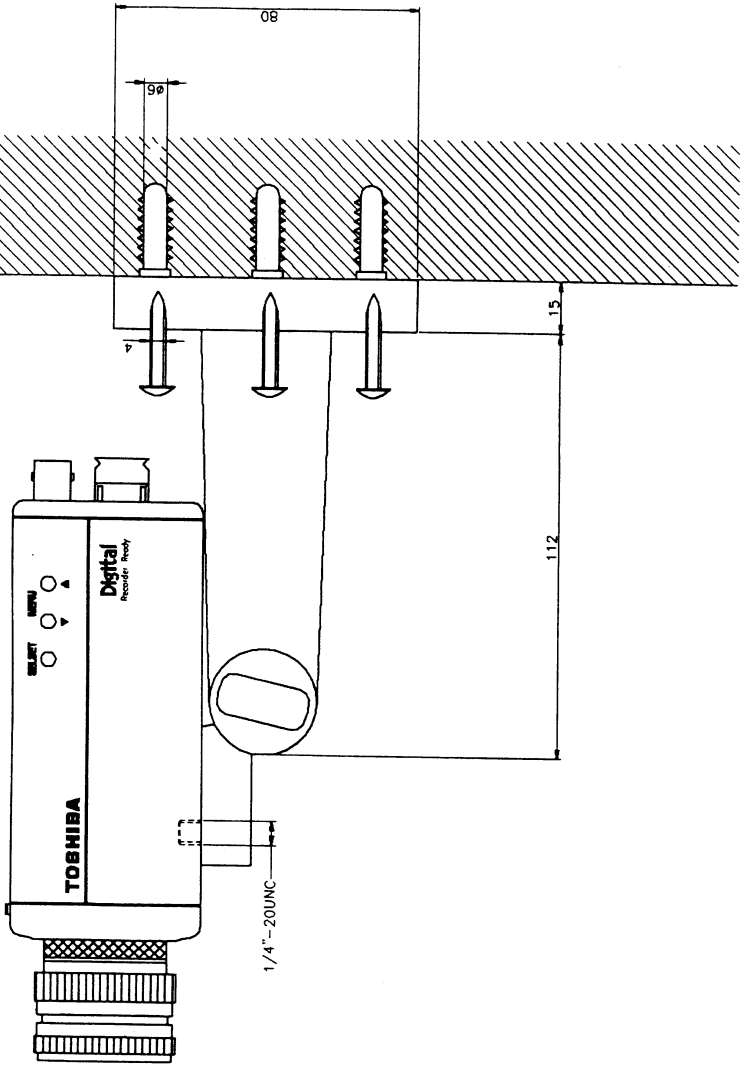

The Installation Guide is for reference only.  
Bracket is not be enclosed.